

LP Morgan **Galleria** manual



Installation Instructions For:

- Plana U
- Novares
- Rear Projection
- Plana AT

Table of contents

To the owner	3
Unpacking	4-5
Assembly instructions	6
Attaching the screen material	7-10
Trimming the screen material	10
Installing the assembled screen	11
Mounting the screen	12
Screen care	13-14
Warranty information	15

Information in this document is subject to change without notice.

© Herma Technologies. All rights reserved.

This document is protected against unauthorised copying electronic or otherwise.

Trademarks used in this text: Herma, the Herma Logo, Galleria, LP Morgan and LP Morgan logo are registered trademarks of Herma Technologies.

Other trademarks and trade names used in this document remain the property of the relevant owners.

June 2011 Version 3.2

To the owner

Congratulations on purchasing an Australian made LP Morgan CineTheatre Galleria Projection Screen. This cinema quality screen uses the finest optical and mechanical components to give you a truly cinematic experience.

Please take a moment to review this manual, as it will ensure you many years of service from your new LP Morgan CineTheatre Galleria Projection Screen.

Required tools and parts

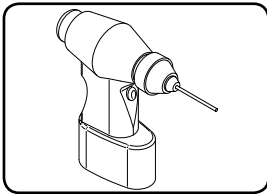

Electric drill with drill and driver bits

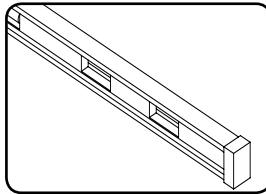

Spirit level and pencil for marking

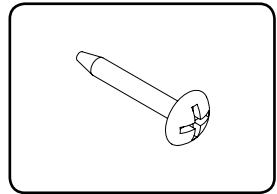

6 or more screws to suit wall type.
(Screw heads must be no higher than 4mm)

Unpacking the Galleria Frame Screen (Plana U / Novares / Rear Projection)

Supplied parts

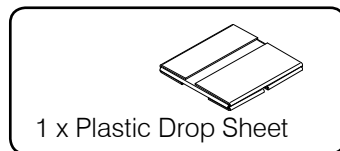
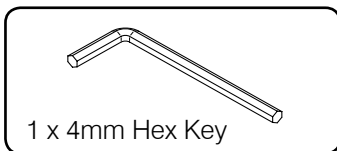
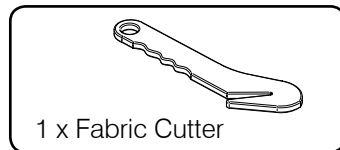
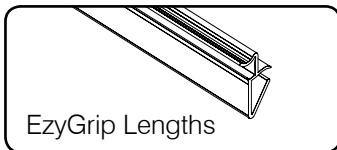
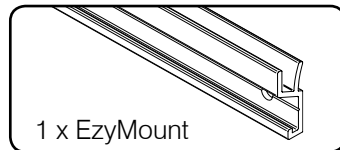
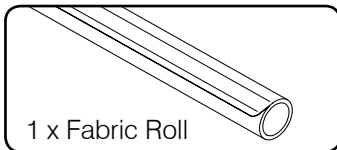
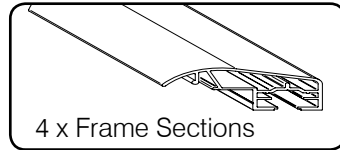
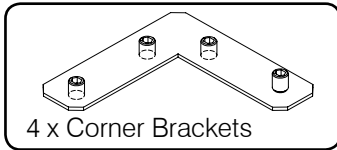

Please check that you have all the components before assembly.
The EzyGrip and EzyMount are packed inside the fabric roll.

Front Projection Screens 140" and larger contain extra components.
See page 10.

Unpacking the Galleria Frame Screen (Plana AT)

Supplied parts

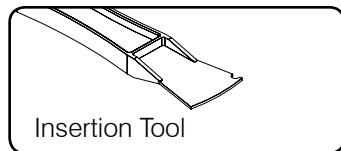
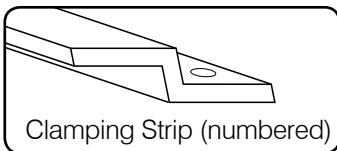
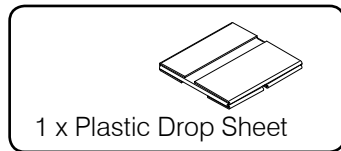
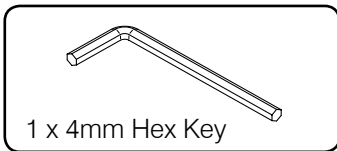
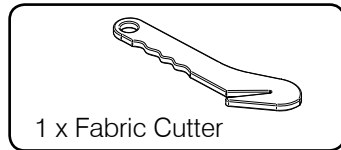
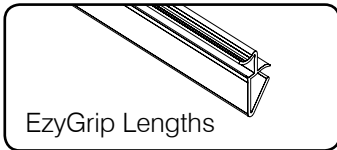
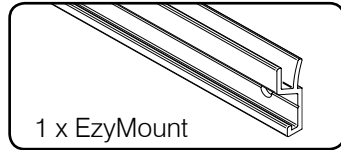
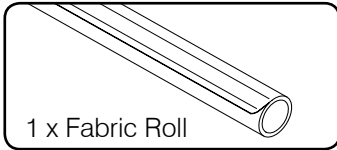
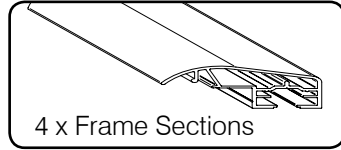
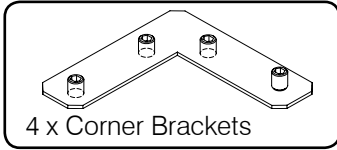

Please check that you have all the components before assembly.
The EzyGrip and EzyMount are packed inside the fabric roll.

Screens 140" and larger contain extra components.
See page 10.

Assembling the screen

Assemble the frame face down on a flat surface on the plastic drop sheet provided. Please read the instructions carefully to avoid mistakes.

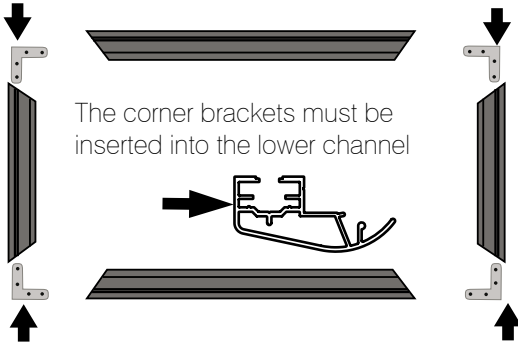

The corner brackets must be inserted into the lower channel

Insert the corner brackets into the short frame pieces first. Be sure to insert them into the lower channel and that the grub screws are accessible through the slot.

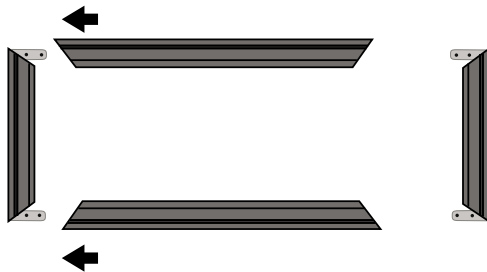

Attach the long frame pieces into one end of the short frame piece.

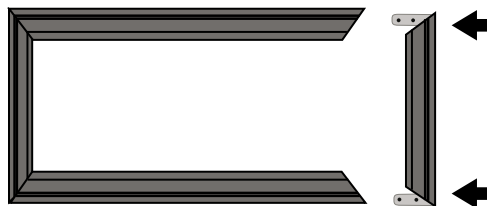

Insert the second short end piece into the long frame pieces.

Check that all corners are firmly fitted together before tightening the grub screws with the supplied hex key.

Attaching the screen material (Plana U / Novares / Rear Projection)

Roll the screen material onto the back of the screen. There is a sticker attached to show you which side is the viewing side.



The material is held in the frame with EzyGrip. The EzyGrip sits in its special channel to hold the tension in the screen.

Correct insertion of EzyGrip

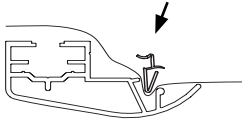

EzyGrip in the wrong channel

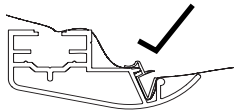
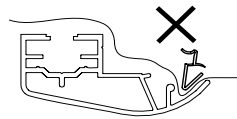

EzyGrip in the wrong way around



Insert EzyGrip in the order shown below. Start at the corner of the frame and work along the edge. Cut to length if necessary. Following the diagram below insert the EzyGrip into the first side then when installing on the opposite side apply tension to the fabric with one hand while inserting the EzyGrip with the other.

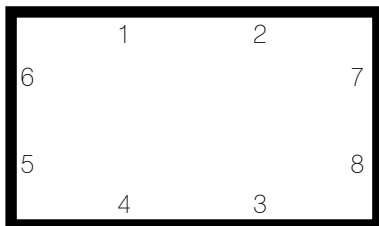

- Insert the EzyGrip in the order shown
- Avoid lifting up the fabric, as the EzyGrip may pop out

Attaching the screen material (Plana AT)

Roll the screen material onto the back of the screen. There is a sticker attached to show you which side is the viewing side.



The material is held in the frame with EzyGrip. The EzyGrip sits in its special channel to hold the tension in the screen.

Correct insertion of EzyGrip

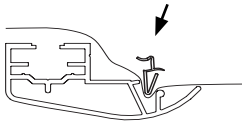

EzyGrip in the wrong channel

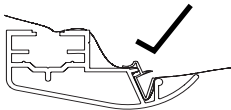
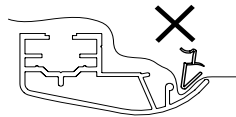

EzyGrip in the wrong way around

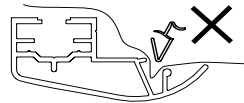

Allow enough fabric to overlap the frame sides to ensure the fabric can be tensioned by hand.

LP Morgan Galleria Manual

Start at the first corner of the joined frame and work around the edge. Following the diagram below, insert the EzyGrip along the first side.

You can insert the lengths of EzyGrip in either a clockwise or anticlockwise direction.

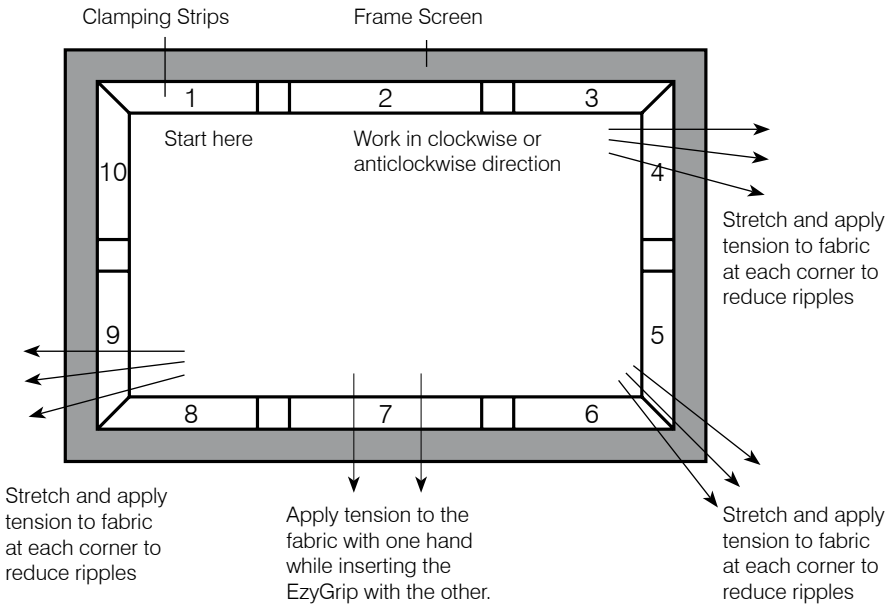

Insert the first section of EzyGrip into the correct channel using your fingers, or hand tool provided.

Cut EzyGrip to length if necessary. Screw a matching numbered piece of Clamping Strip to secure each length of EzyGrip in place as you progress. This will stop the EzyGrip pulling out as tension is applied to the fabric surface.

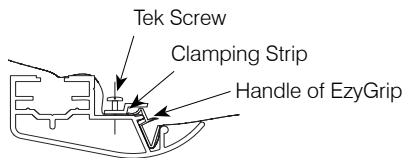

If you have ripples or creases in the image area, don't panic! You can easily remove the EzyGrip, retension the surface and re-install the EzyGrip.

For Plana AT:

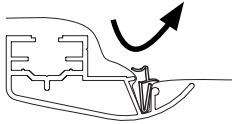

1. Remove the clamping strip.
2. To remove the EzyGrip push the handle forward, then lift it up to remove.
3. Fix the clamping strip.

Trimming the screen material

Be sure you have the tension correct before trimming the screen material, as it is best not to remove the EzyGrip after trimming. Trim the excess fabric with the fabric cutter supplied.

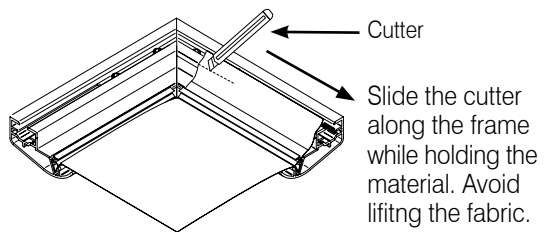
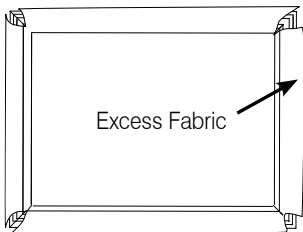

- Hold the fabric with one hand, while sliding the cutter along the inside edge of the frame.
- Avoid lifting up the fabric, as the EzyGrip may pop out.

Installing the assembled screen

Installing the EzyMount

Carefully measure the desired screen position. Always use a spirit level as the ceiling or walls may not be level. Measure, drill and fasten the EzyMount to the wall using at least three screws appropriate to the wall type (not supplied).

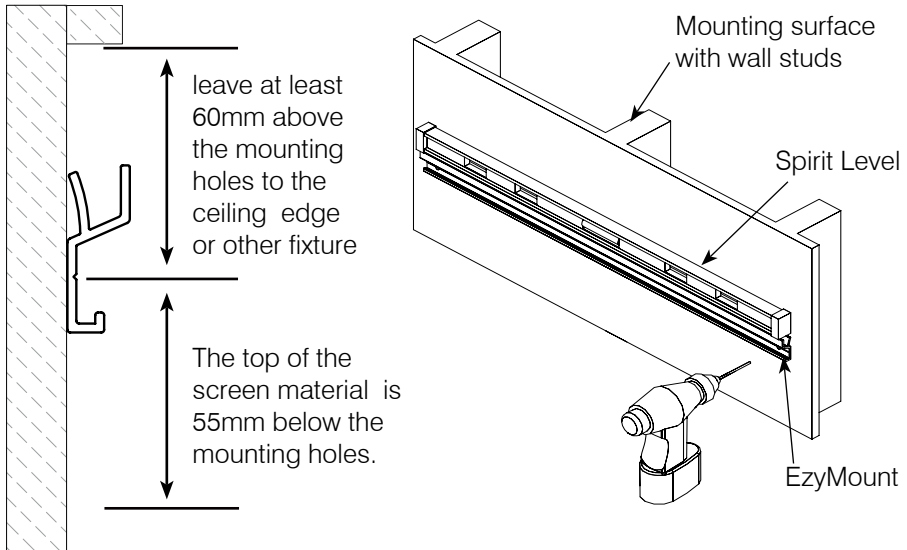

For Front Projection Screens 140" and larger (not applicable for rear pro fabric)

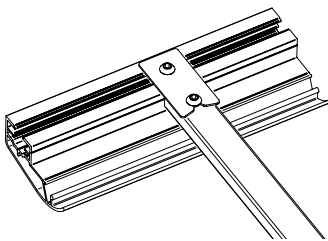

Screens 140" and over in size include a cross brace. The tabs are already attached to the frame and the bolts are installed on the brace. Using the Hex key loosen the bolts, install the brace in the middle of the screen then re-tighten the bolts.

If your frame has an included cross brace then it is supplied with two lengths of EzyMount. When mounting the EzyMount leave a 150mm space in between the two lengths. This space is for the brace and for lateral screen adjustment to align your picture.

Mounting the screens

Tilt the screen 15° to hook onto the EzyMount. When you have hooked the screen onto the EzyMount then lower it against the wall.

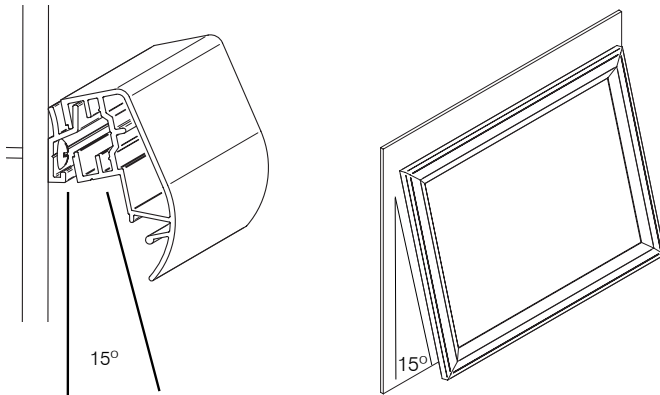

Slide the screen sideways along the EzyMount to line up with the image. Make sure the projector is perpendicular to the screen.

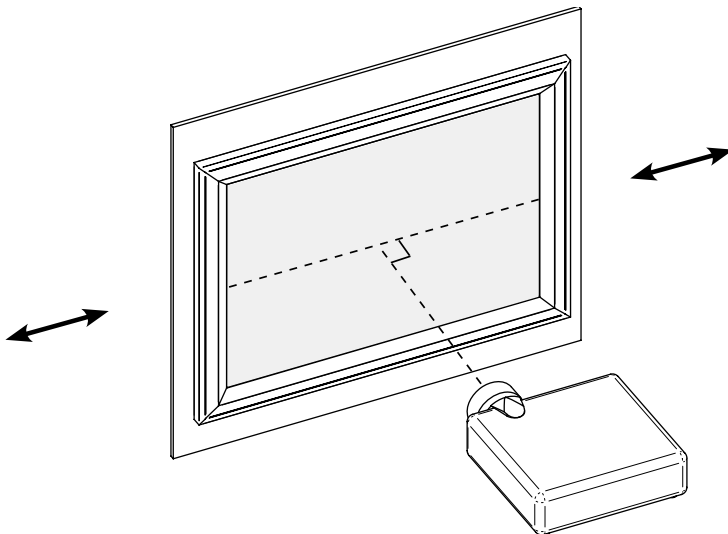

Screen care

Cleaning your Galleria Screen Surface

(Plana U / Novares / Rear Projection)

- Never use solvents, chemicals or abrasive cleaners on the screen.
- Never use a scraper, razor blade or other sharp object to clean the screen.
- Use a soft cloth to remove any loose dirt or dust particles.
- Clean the screen with a mild detergent solution and a sponge or lint free cloth. Dab lightly to remove any stubborn marks, then blot with a damp sponge to absorb excess water. Dab off the detergent with clean water and dry with a soft cloth or towel. Do not let the detergent dry on the screen.

Cleaning your frame

- If your frame is powder-coated or anodised, use water with a mild detergent or methylated spirits and a soft cloth to wash off any marks. Rinse and dry with a clean cloth or towel. Take care not to wet the screen surface.
- If your frame features a flocked velour finish, use a lint brush to remove any dust on the frame.

Screen care

Cleaning your Plana AT surface

- Remove dust with vacuum cleaner or compressed air.
- Do not scrub. Do not use solvents or any abrasive substance which might damage the coating of the fabric.
- For small stains removal, try rubbing the fabric very gently with a clean white pencil eraser.
- Clean the screen with a mild detergent solution and a sponge or lint free cloth. Dab lightly to remove any stubborn marks, then blot with a damp sponge to absorb excess water. Dab off the detergent with clean water and dry with a soft cloth or towel. Do not let the detergent dry on the screen.

Cleaning your frame

- If your frame is powder-coated or anodised, use water with a mild detergent or methylated spirits and a soft cloth to wash off any marks.
- Rinse and dry with a clean cloth or towel. Take care not to wet the screen surface.
- If your frame features a flocked velour finish, use a lint brush to remove any dust on the frame.

Warranty information

Keep your original receipt for warranty.

Please fill out the online warranty form in order to qualify for the manufacturer's warranty.

<http://www.lpmorgan.com.au/owners.html>

The warranty covers defects in workmanship and materials, provided this product has been installed in a normal environment and maintained according to the written instructions. Herma warrants the product against loss of usefulness, discolouration or deterioration of optical quality within the warranty period as a result of manufacturing or material defects. This warranty applies only within Australia.

Please return your goods to the place of purchase for all warranty claims.

Conditions

Any equipment replaced pursuant to the terms of this warranty shall be retained by Herma.

All costs related to de-installation and re-installation of the product covered by this warranty are not the responsibility of Herma Technologies. Herma will not be responsible for any consequential damages during or following installation procedures.

Herma is not responsible for any freight costs relating to repair or replacement. Equipment must be returned to Herma in suitable packing to prevent damage in transit. Herma will not accept any responsibility for damage to the equipment caused by inadequate or unsuitable packing, or for any damage howsoever caused whilst the goods are in transit.

Herma Technologies shall not be liable for any injury, loss or damage, direct or consequential, arising out of the use of, misuse of, or inability to use, the equipment.

This Warranty does not cover any product which has been subjected to misuse, abuse, neglect, accidental or intentional damage, improper voltage or any alteration which affects the reliability or performance of the equipment not attributable to faulty manufacture, parts or labour and without limiting the generality of the foregoing.

This Warranty does not cover any product where usage, adaptation or installation are not in accordance with our written installation and operating instructions.

Warranty Periods:

- Galleria Frame and Assembly Hardware: Two years from date of purchase.
- Screen Surface: One year from date of purchase.

**For more information on our range of products,
please visit www.lpmorgan.com.au, or contact
your local LP Morgan Retailer.**

Factory 4a, 6 Albert Street Preston Vic 3072

Phone: +61 3 9480 6233 **Fax:** +61 3 9480 6533

Email: info@herma.com.au www.lpmorgan.com.au

June 2011 Version 3.2

